

Push Trolley and Gear Trolley Dimensions & Specifications

Push Trolley Dimensions & Specifications

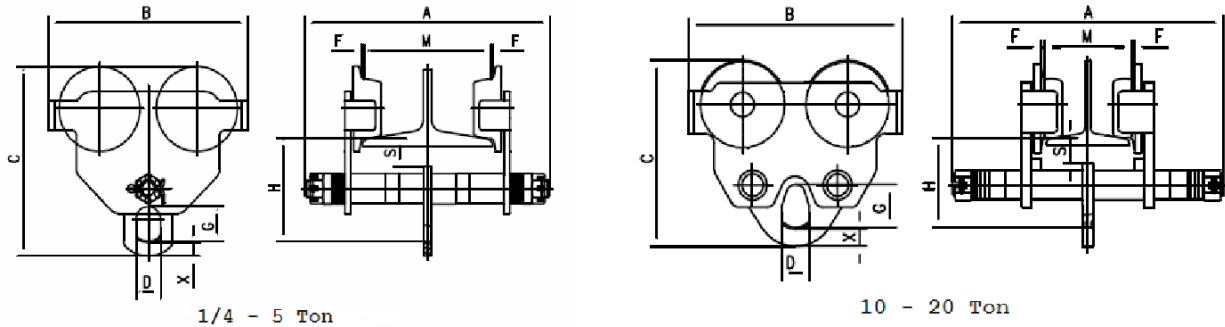

Model	PT-005-S	PT-010-S	PT-020-S	PT-040-S	PT-060-S	PT-060-L	PT-100-S	PT-100-L	PT-200-L	PT-400-L	
Rated Capacity (Tons)	¼	½	1	2	3	3	5	5	10	20	
Min. radius of curve (ft.)	2.6	2.6	3.3	3.6	4.3	4.3	4.6	4.6	6.6	11.5	
Diameter of wheel (in)	2.3	2.3	2.9	3.5	4.3	4.3	4.8	4.8	5.9	7.9	
Dimensions (in)	A	9.6	9.6	12.2	12.9	13.5	17.5	14	18	20.1	23.8
	B	7.6	7.6	9.7	10.9	13.1	13.1	14.8	14.8	16.7	23.8
	C	7.4	7.4	8.7	10.3	12.2	12.2	13.9	13.9	15.6	19.6
	H	4.1	4.1	4.9	5.9	6.7	6.7	7.7	7.7	7.5	9.2
	S	1.2	1.2	1.5	1.5	1.6	1.6	1.7	1.7	1.8	2.3
	D	1	1	1.2	1.5	1.6	1.6	2	2	2.8	3.7
	X	0.63	0.63	0.63	0.75	0.88	0.88	1.13	1.13	2	3.5
	G	1.3	1.3	1.6	2	2.5	2.5	3	3	4.3	5.3
F	0.10-0.12										
I-beam width range (in)	M	2.0-6.0	2.0-6.0	2.5-8.0	3.5-8.0	4.0-8.0	4.0-12.0	4.5-8.0	4.5-12.0	4.9-12.0	5.4-12.00
Net Weight (lbs)	15.4	15.4	26.5	48.5	66	80	85	100	205	518	

Gear Trolley Specifications & Dimensions

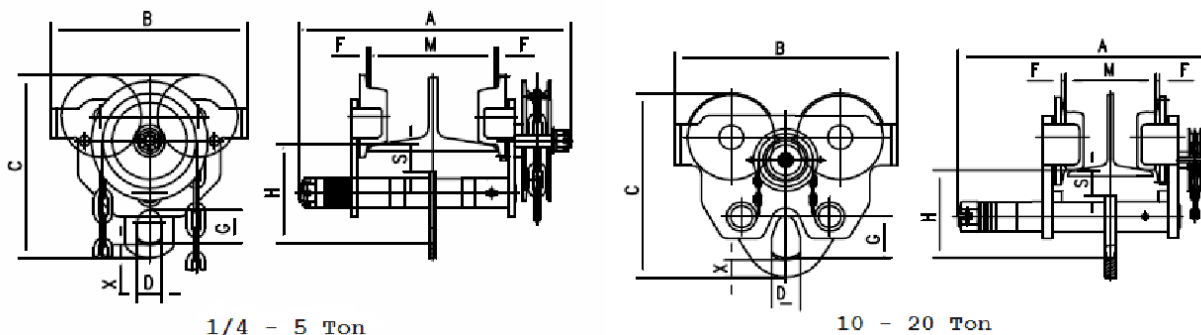

Model	GT-005-S	GT-010-S	GT-020-S	GT-040-S	GT-060-S	GT-060-L	GT-100-S	GT-100-L	GT-200-L	GT-400-L	
Rated Capacity (Tons)	¼	½	1	2	3	3	5	5	10	20	
Standard Hand Chain Drop	8 ft.										
Min. radius of curve (ft)	3.3	3.3	3.3	3.6	4.3	4.3	4.6	4.6	6.6	11.5	
Diameter or wheel (in)	2.9	2.9	2.9	3.5	4.3	4.3	4.8	4.8	5.9	7.9	
Dimensions (in)	A	13.3	13.3	13.3	13.7	14.3	18.3	14.7	18.7	20.1	23.8
	B	9.7	9.7	9.7	10.9	13.1	13.1	14.8	14.8	16.7	23.8
	C	8.7	8.7	8.7	10.3	12.2	12.2	13.9	13.9	15.6	19.6
	H	4.9	4.9	4.9	5.9	6.7	6.7	7.7	7.7	7.5	9.2
	S	1.5	1.5	1.5	1.5	1.6	1.6	1.7	1.7	1.8	2.3
	D	1.2	1.2	1.2	1.5	1.6	1.6	1.7	1.7	1.8	2.3
	X	0.63	0.63	0.63	0.75	0.88	0.88	1.13	1.13	2.00	3.5
	G	1.6	1.6	1.6	2.0	2.5	2.5	3.0	3.0	4.3	5.3
F	0.10							0.10-0.14			
I-beam width range (in)	M	2.5-8.0	2.5-8.0	2.5-8.0	3.5-8.0	4.0-8.0	4.0-12.0	4.5-8.0	4.5-12.0	4.9-12.0	5.4-12.0
Net Weight (lbs)		31.0	31.0	42.0	64.0	88	95	108	113	227	540